

Technical Specifications

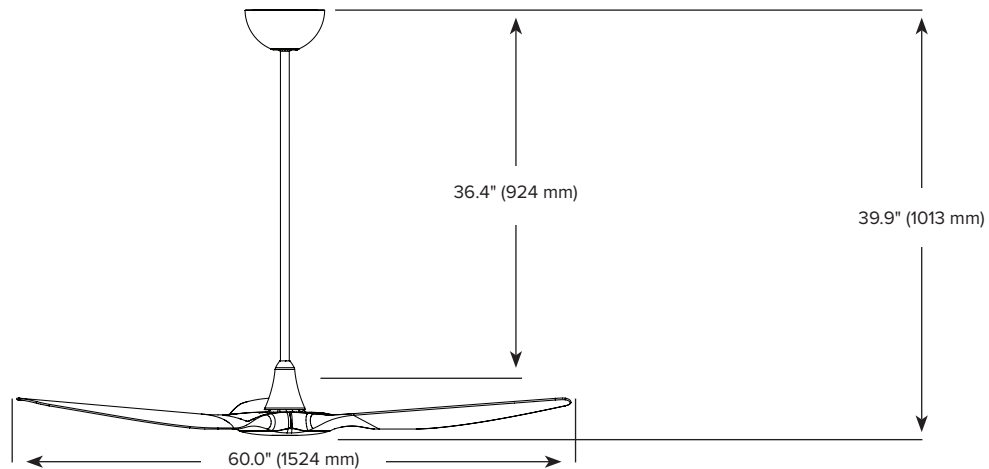

Technical Specifications	
Model	Haiku® Bamboo
Model number	S3150-XO-32
Fan diameter	60 in. (1524 mm)
Motor and assembly finishes	Black or white
Airfoil material	Bamboo
Airfoil finishes	Caramel or Cocoa
Number of airfoils	3
Motor type	EC motor with a digital inverter drive
Controller included	Yes, remote
Controller features	On/off
	Sleep mode
	Off timer
	Whoosh mode
	Reverse
Mount and drop tube	39.9" (1013mm)
Hanging weight	13.5 lb (6.1 kg)
Number of fan speeds	7
Operating voltage	100–240 VAC, 1Φ
Operating frequency	50–60 Hz
RPM (min/max)	35/195 RPM
Amps (min/max)	0.05 - 0.363 A
Watts (min/max)	2/30 W
Ambient operational temperature range	32°–120° F (0–49° C)
Environment	UL listed for dry locations
Fan mode indicator	LED display
Warranty*	Limited lifetime

Controller

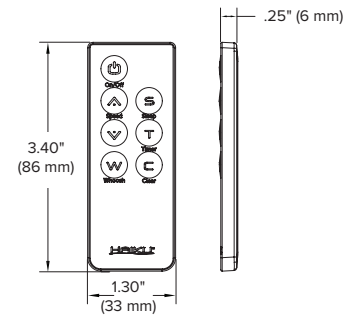

Color Options



* See Haiku warranty in installation guide for complete details